



SERVICE TEMPERATURE FOOD PRESERVER THE HOT FRIDGE

USE AND MAINTENANCE MANUAL
Translation of the original instructions

EN

CAUTION: Read the instructions before using the appliance



THANK YOU FOR CHOOSING EVEREO BY UNOX

You have purchased a hi-tech product that will revolutionise the way you manage your kitchen.

SERVICE TEMPERATURE FOOD PRESERVER

SAFETY REGULATIONS

SAFETY REGULATIONS FOR USE	6
PICTOGRAMS.....	8

INTRODUCTION / BASIC NOTIONS

HOW EVEREO® WORKS	10
MODES	10
WARNINGS AND ADVICE.....	11

USE

HOME SCREEN	12
GUIDED PROCEDURE.....	13

MAINTENANCE

ROUTINE MAINTENANCE.....	70
INACTIVITY	72
CERTIFICATION	72
WARRANTY	72
DISPOSAL.....	73

SAFETY REGULATIONS FOR USE

- Following procedures other than those indicated in this manual to use and clean the appliance is considered inappropriate and may cause damage, injury or death; in addition, this invalidates the warranty and any other contractual relationship with the manufacturer and its subsidiaries/associates, and relieves the manufacturer of all liability.
- The appliance can be used by children of 8 years and over and by people with reduced physical, sensory or mental capabilities or people lacking the experience or knowledge needed, provided they are supervised or have received instructions relative to the safe use of the appliance and that they understand the inherent dangers. Children must not play with the appliance. User cleaning and maintenance must not be carried out by unsupervised children.
- User cleaning and maintenance must not be carried out by unsupervised children.
- Children must be supervised to ensure they do not play with the appliance.
- This appliance can only be used at low temperatures to cook food or keep it warm, according to the manufacturer's instructions, in industrial and professional kitchens, and by qualified personnel who have completed scheduled training courses. Any other use is not compliant with the scope of use and is therefore hazardous.
- If the appliance does not function or if there are any functional or structural alterations, disconnect the electricity and contact a customer assistance service authorised by the manufacturer. Do not attempt to repair the appliance yourself. For any necessary repairs, please request that

- original spare parts from the manufacturer be used.
- Failure to follow these regulations may cause damage, injury or death, and invalidates the warranty and any other contractual relationship with the manufacturer and its subsidiaries/associates.

RISK OF BURNS and INJURY

- While keeping foods warm and until all parts of the appliance have cooled, be careful to:
 - only touch the appliance control components or the handle because the external parts may be extremely hot (temperature above 60°C/140°F);
 - wear appropriate protective heat-resistant clothing to move containers, accessories and other objects inside the holder cabinet cavity.
- Open the door (where necessary) slowly and with the utmost caution, as the temperature inside the appliance cavity is extremely hot.
- Do not remove or touch the protective fan casing, the fans or the heating elements while the appliance is turned on and until it has completely cooled down.

RISK OF FIRE

- Before using the appliance, make sure that there are no non-compliant objects (instruction manuals, plastic bags, etc.) or detergent residue inside the appliance cavity. Also make sure that the flue is free of obstructions and that there are no flammable materials in the vicinity.
- Do not place sources of heat (e.g. grills, fryers, etc.), highly flammable substances or fuels (e.g. diesel, petrol, bottles of alcohol, etc.) near the appliance.
- Do not use highly flammable liquids (e.g. alcohol) inside

the appliance chamber.

- Always keep the appliance cavity clean by cleaning daily.

RISK OF ELECTRIC SHOCK

- Do not open the compartments marked with this symbol: access is for qualified personnel authorised by the manufacturer only. Failure to follow these regulations invalidates the warranty and any other contractual relationship with the manufacturer and its subsidiaries/associates.

PICTOGRAMS

The installation and user instructions are valid for all models unless otherwise specified by the following pictograms:



Danger! Situation presenting immediate danger, or a hazardous situation which could cause injury or death.



Risk of fire



Tips and useful information



Risk of electric shock



Earthing symbol



Read the instruction manual



Equipotential symbol



Risk of burns



Consult another section

Introduction

Dear Customer,
Thank you for choosing to purchase this appliance ; we hope this is just the beginning of a long-lasting partnership.



We recommend that you read this manual carefully, as it contains all of the instructions on how to maintain the aesthetic and functional qualities of your product.



Basic notions

HOW EVEREO® WORKS

Bacteria, which are responsible for the degradation of food, proliferate at temperatures of between 4°C and 58°C. For this reason, one of the most commonly used methods for preserving food has, up until now, been that of freezing foods at temperatures below 4°C. The food is then regenerated when required.

What happens if food is kept at a temperature **exceeding** 58°C for a number of days?

To answer this question, UNOX has used its experience together with the Department of Material Physics of the University of Parma.

After years of research, an intuition has become scientific certainty: food can be stored for long periods at temperatures exceeding 58°C, without compromising taste and flavour, through the combined and accurate control of temperature, humidity and oxygen that comes in contact with it. This is how EVEREO® came into being, an appliance designed to store food at service and consumption temperature for days. This means food can be cooked, kept hot (within a range of 62°C to 70°C) and served within just a few seconds at any time of day, with zero waiting times for customers.

All this combined with microbiological safety, the preservation of the organoleptic qualities of food, and savings in terms of both time and resources.

If food below 60°C is placed in EVEREO to cook/regenerate, the temperature of the food must be monitored to verify that the time/ temperature profile is safe and specifically to ensure that it meets required standards to disable target microorganisms.

Do not use the appliance to store food at a starting temperature below 0°C. Evereo cannot guarantee in this case that the time/temperature profile to disable target microorganisms meets required standards.

MODES

Up to 72 hours: preserving mode (MULTI.DAY MODE)

If this mode is used, simply hermetically seal cooked food while it is still hot using a simple vacuum bag or an MULTI.Day Trays.

EVEREO® independently suggests the right settings to be used for the most common foods. This way the natural moisture in the dishes together with their organoleptic qualities are maintained.

* If storage is done using MULTI.Day Trays, wait 4/5 minutes to vacuum with MULTI.Day HOT VACUUM if the temperature of the food is higher than 180°C. This ensures the vacuum in the tray.

Up to 8 hours: holding mode (SUPERHOLDING MODE)

If this mode is used, food can be kept warm and cooked in uncovered containers for up to 8 hours with flawless results. Simply set the temperature and the humidity level that best fits the food to be kept.

Up to 72 hours: MEAL ME MODE

Dishes ready to be served can be ordered directly by smartphone and stored in a modified atmosphere. They are delivered at temperatures below 4°C.

The food purchased must then be kept in EVEREO® for at least 8 hours before serving.

WARNINGS AND ADVICE

 **Before using the appliance, carefully read the section “[Safety regulations](#)” on page 6.**

- When using the appliance for the first time, be sure to clean the inside of the oven cavity and the accessories thoroughly (see the [Maintenance](#) section on page 74); let the oven run empty at 70°C (maximum temperature) for approximately 1 hour to eliminate any unpleasant odours caused by the protective factory grease.
 - If the appliance has been left running for more than 15 minutes without an operating mode being selected, stand-by is automatically engaged to save energy. To exit this mode, touch the START/STOP button.
 - Use the appliance where the room temperature is between +5°C and +35°C.
 - Use the manufacturer’s grills and trays. Try to distribute the food evenly on the trays and avoid overloading them or overlapping food.
 - Always respect the loading instructions for your appliance.
-
- The product has a sound pressure level of less than 70dBa.

HOME SCREEN

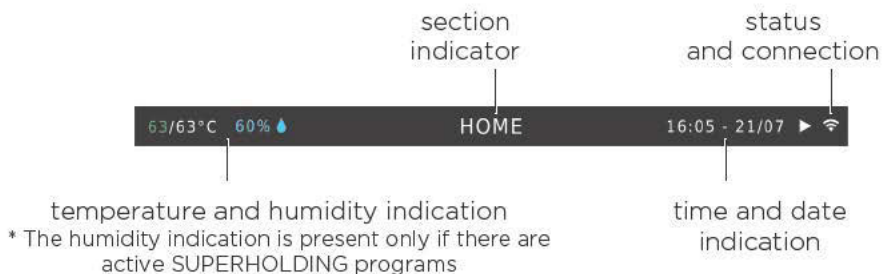
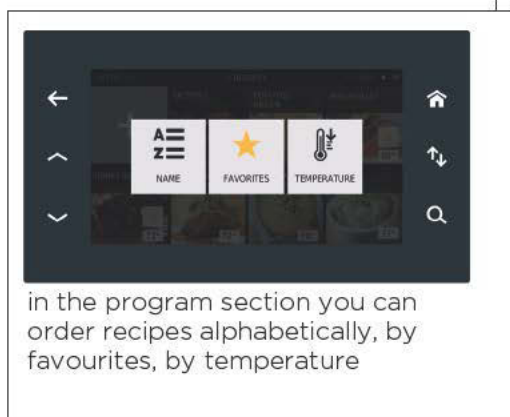
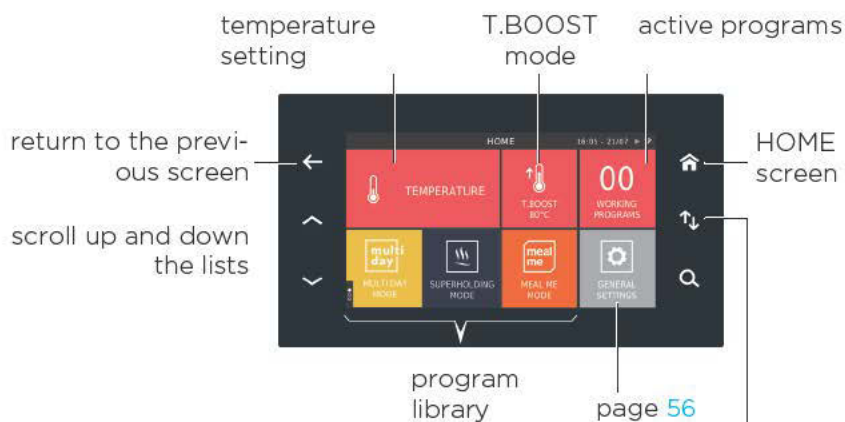

GUIDED PROCEDURE

- A) Choosing how to manage portions ▶ page 14
- B) Setting temperature of use (set point) ▶ page 16
- C) Selecting the mode and a program (already present or a new one) ▶ page 19
 - Up to 72 hours: preserving vacuum packed portions (MULTI.Day MODE) ▶ page 20
 - Up to 8 hours: holding mode (SUPERHOLDING MODE) - open portions ▶ page 26
 - Up to 72 hours: preserving vacuum packed portions (MEAL ME MODE) ▶ page 32
- D) T.BOOST mode - preparing food for service ▶ page 34
- E) Starting up the program selected ▶ page 36
- F) Switching off the appliance ▶ page 52
- G) SETTINGS ▶ page 56
- H) Configuring and using Evereo SAFE.Lock ▶ page 62

A) Choosing how to manage portions: by tray or by list

There are two portion management modes in EVEREO®:

- default managing by **TRAY** (TRAY VIEW),
- managing by **LIST** (LIST VIEW).

You can set your preferences by accessing the menu:

General settings -> preferences -> portion view.

In the Portions view menu you can choose:

- 1) to manage portions by **tray** or by **list** (see next page for further information);
- 2) activate or deactivate the **portion request** at program start-up;
- 3) request **the tray number** (activated only if list view has been selected).

! To make the selection the temperature must be halted and no programs must be active.

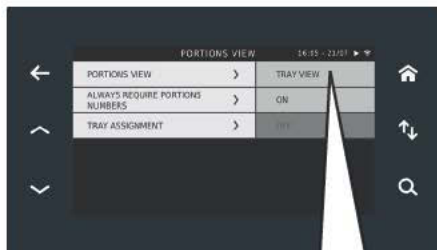
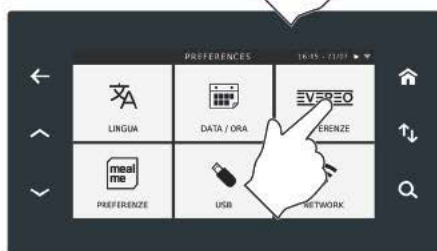
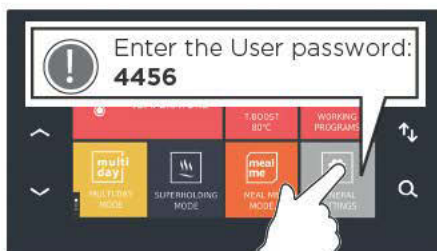

Managing by TRAY (TRAY VIEW):

In this mode you can quickly manage the portions and keep all the programs started in EVEREO® under control.

TRAY management is optimised for the use of the reorder point function.

Screen

Tray view

This screen shows the programs which are active in EVEREO® and on which tray have been loaded.

By selecting the tray (where a program is active), the portions which have been put into EVEREO® are displayed.



Tray

For each Timer, a new item is created in the list. This way EVEREO® can make a distinction between the portions which have been put in at different times.

Example:

Timer 01 - 12 portions

Timer 02 - 05 portions

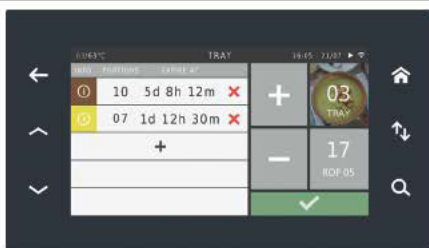

Screen

Tray view

In this screen EVEREO® loads all the portions of the programs. Portions can be ordered by expiry date, alphabetically and, if entered, by tray.



EN

B) Setting temperature of use (set point)

- 1 Touch the red field "Temperature".



Alternatively, I can choose to:

- use a **temperature already present** because it is in the pre-set factory settings, or because it was saved previously: 62°C, 70°C, recommended temperatures for holding food in EVEREO®
 - ▶ go to point 5
- set a **new temperature** (e.g. 63°C) if those present are not what I need
 - ▶ continue with point 2

- 2 Touch the "+" button to create a new temperature.



Set the required value using the "-" and "+" buttons or by dragging the cursor (in the example, 85°C), then confirm using "✓" or cancel using "X".

- 3  A password has to be entered if temperatures of less than 59°C are to be set. The user is also notified by a pop-up window that the temperature does not guarantee food safety.



After confirming, the screen will show the temperature set (in the example, 63°C). This is useful as it can be reused again in the future without having to be reset.

④

If it is no longer needed, it can be deleted by touching "X" in the same box and confirming with "✓" or cancelling with "X".

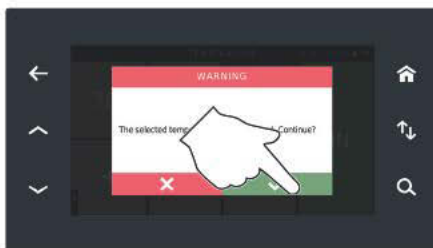

⑤

Touch the relevant temperature (in the example, 63°C).

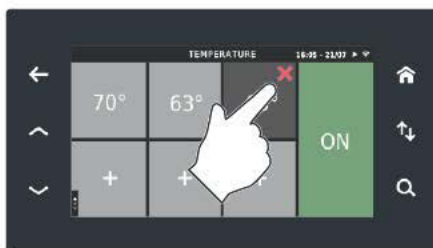

⑥

Touch the "ON" field to start the reheat function.



Do not put any more food into EVEREO®.



The figure to the side shows the current temperature in the cavity (in the example, 45°C) and the temperature set (in the example, 63°C).

- ⑦ When the temperature set is reached, the temperature field and the one to the side will become green: EVEREO® is **ready for use**.



C) Selecting the mode and a program (already present or a new one)

- ① Choose from one of three different modes:

 **Up to 72 hours: preserving vacuum packed portions (MULTI DAY MODE)** ► page 20

 **Up to 8 hours: SUPERHOLDING MODE - open portions (SUPERHOLDING MODE)** ► page 26

 **Up to 72 hours: vacuum-packed portions (MEAL ME MODE)** ► page 32

 For additional information, see page 10

After the selection has been made, all the programs present are displayed (both the programs pre-set in the factory and those saved previously).



Up to 72 hours: MULTI DAY MODE - First operation

**multi
day**

Service Temperature Food Preserving using EVEREO® MULTI.Day avoids bacteria proliferation in cooked meals. Meals that need to be preserved must be prepared and cooked strictly following foodsafety procedures and laws.

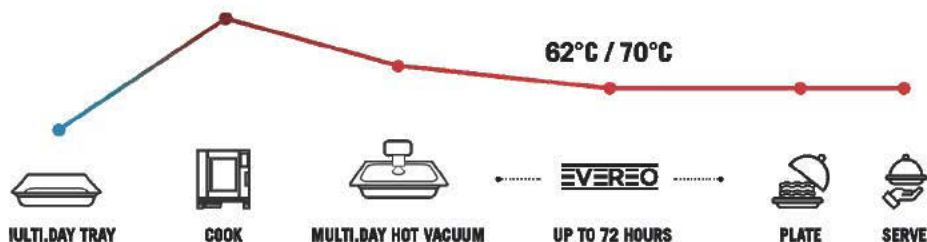

! Evereo MULTI.Day Trays

Proper sterilization of MULTI.Day Trays & lids is required prior to cooking and preserving (20 min, 120°C, 100% Steam or 5 min, 180°C, 40% Steam). Before serving, anything that looks or smells suspicious should be thrown away.



Up to 72 hours: MULTI DAY MODE - vacuum packed portions

I can choose to:

- use a **program already present** because it is in the pre-set factory settings, or because it was saved previously

▶ go to page [25](#)

or

- set a **new program** - “**MULTI DAY MODE**”

▶ see next section

[Setting a new program - MULTI DAY MODE](#)

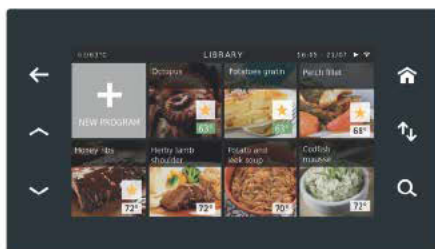

The screen shown is an example; it depends on the programs set by the user.

EN

Setting a new program - MULTI DAY MODE

- A** Select “**+ New Program**” to create a new program.



- B** Select the **category** to which the food type you wish to keep belongs (e.g. soup - salsa - sauce), choosing from those suggested.



- C Select the **picture** of the food to be introduced or, alternatively, select “My Photo” and choose a personal picture. To find out how to add a personal picture ► go to page 60



- D Select the **present temperature** of the food to be kept (i.e. the temperature of the food before being introduced into EVEREO®, in the example over 57°C). This parameter is used to determine the correct pasteurization temperature required for food safety.

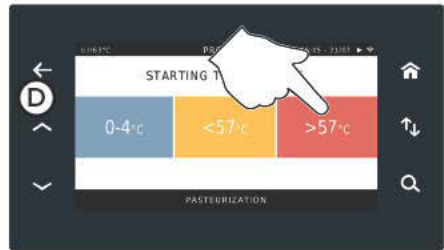

- ! Do not serve the food before the pasteurization time has elapsed.

The program will auto-fill all its fields and enter the default values (see page 73).

- name (e.g. soup)
- photo
- category (e.g. soup)
- temperature (e.g. 63°C)
- timer (5 days and 12 hours)
- pasteurizations (in this case it is not required because the food was already hot when introduced).

📄 If you want to:

- **manually change** these values, see page 24;
- enter a **reorder point (ROP)** and mark the program as a “**favorite**”, see page 23.
- **immediately start up** the program, see page 36



- A **Temperature:** holding temperature of food in EVEREO®.

- B **Regeneration time:** the number of hours after which the food can be served once it has been put into EVEREO®. This time varies depending on the temperature of the food at the time it is put in.

- C **Preserving time (timer):** for how many days the food can be preserved at the indicated temperature.

Completing new program (name, favorite and reorder point)

If you want, change the **name** of the program (e.g. make “Soup” -> “Potato and leek soup”) by keying it in on the keypad and confirming with “✓”.

If you want, set a **reorder point (ROP)**: this value allows EVEREO® to indicate when the portions of this food are running low (in the example EVEREO® advises when 5 portions remain) so there is time for them to be re-stocked.

! If a reorder point is entered in the program, this must be saved before it can be started.

If you want, select the “★ **Favorites**” button to add the program to the rapid access program list.

If you want, immediately start up the program, see page 36

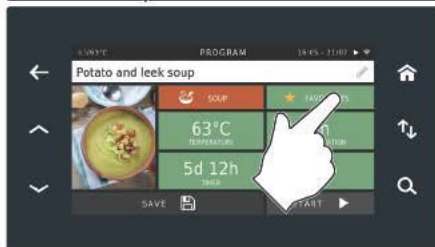
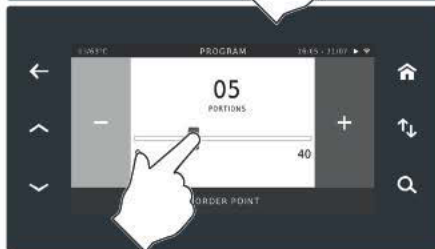
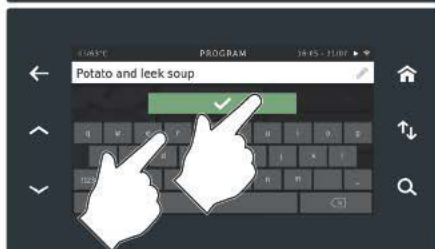

Manual modification of parameters of new program (name, photo, category, temperature, timer and pasteurization)

Touch the corresponding field, set the value and confirm with “√” or cancel by going back with “<-”.



setting the holding temperature



setting the pasteurizing time

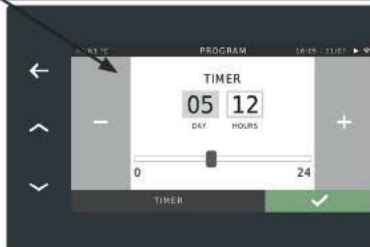

setting the preserving time

WARNING: Food below 60°C!
The temperature of the food must be monitored to verify that the time/temperature profile is safe!

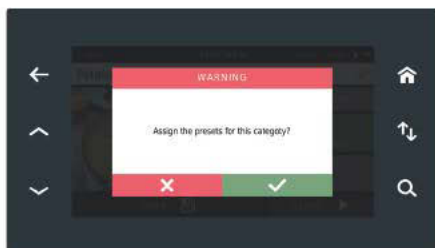

! If, with the parameters already set, the food category is changed, EVEREO® will ask if you want to update the program settings with the parameters of the new category or if you wish to keep the values which have already been entered.



Using a “MULTI DAY MODE - preservation” program that’s already present

- Ⓐ Access the “MULTI DAY MODE” library



- Ⓑ Look for a program which meets your requirements using the arrows  or by clicking on the symbol : this way you can order the recipes alphabetically, by favourites or by temperature.



If you want, immediately start up the program, see page 36

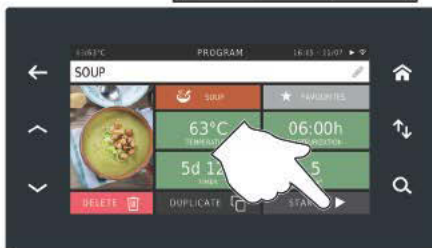

EN

Up to 8 hours: SUPERHOLDING MODE - First operation



Service Temperature Food Preserving using EVEREO® SUPERHOLDING avoids bacteria proliferation in cooked meals. Meals that need to be preserved must be prepared and cooked strictly following foodsafety procedures and laws.

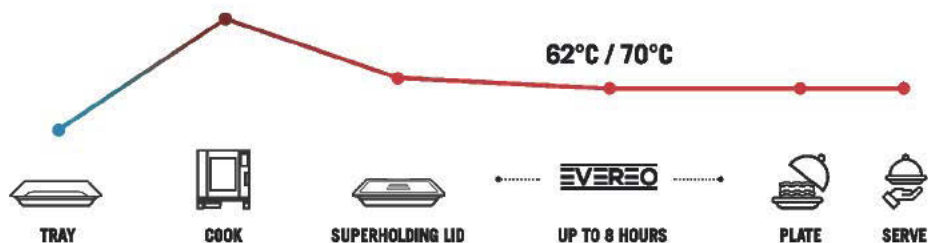

! Evereo SUPERHOLDING

Before serving, anything that looks or smells suspicious should be thrown away.



Up to 8 hours: SUPERHOLDING MODE - open portions

I can choose to:

- use a **program already present** because it is in the pre-set factory settings, or because it was saved previously

▶ go to page 31

or

- set a **new “SUPERHOLDING MODE” program**

▶ see next section “Setting a new “SUPERHOLDING MODE” program”.



The screen shown is an example; it depends on the programs set by the user.

EN

Setting a new “SUPERHOLDING MODE” program

- (A) Select “+ New Program” to create a new program.



- (B) Select the **category** to which the food type you wish to keep belongs (e.g. pasta and couscous), choosing from those suggested.



- Ⓒ Select the **picture** of the food to be introduced or, alternatively, select “My Photo” and choose a personal picture. To find out how to add a personal picture ► go to page 60



The program will auto-fill all its fields and enter the default values (see page 73).

- name (e.g. pasta)
- photo
- category (e.g. pasta)
- temperature (e.g. 65°C)
- timer (e.g. 6.30 hours)
- humidity (e.g. 60%)

Ⓘ If you want to:

- manually change these values, see page 30;
- enter a **reorder point (ROP)** and mark the program as a “**favorite**”, see page 29.
- **immediately start up** the program, see page 36

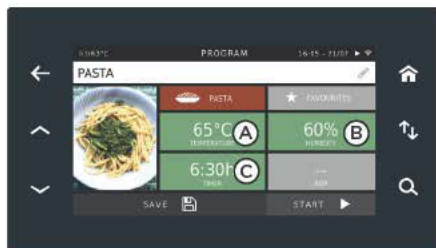

- Ⓐ **Temperature:** holding temperature of food in EVEREO®.
- Ⓑ **Humidity in the cavity:** define optimal humidity depending on the food to be kept.
- Ⓒ **Preserving time (timer):** for how many days the food can be preserved at the indicated temperature.

Completing new program (name, favorite and reorder point)

If you want, change the **name** of the program (e.g. make “Pasta” -> “Pasta with pesto”) by keying it in on the keypad and confirming with “✓”.

If you want, set a **reorder point (ROP)**: this value allows EVEREO® to advise when the portions of this food are running low (in the example EVEREO® flags up when 10 portions remain) so there is time for them to be re-stocked.

! If a reorder point is entered in the program, this must be saved before it can be started.

If you want, select the “★ **Favorites**” button to add the program to the rapid access program list.

If you want, immediately start up the program, see page 36

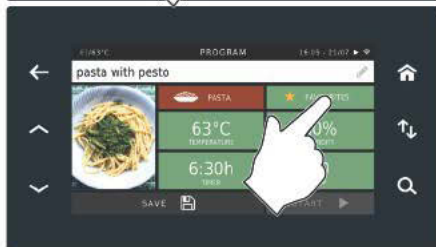
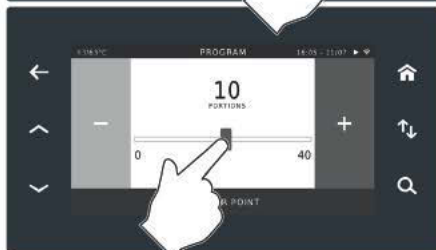
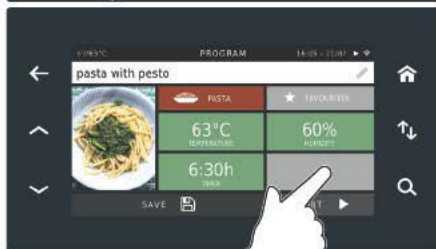
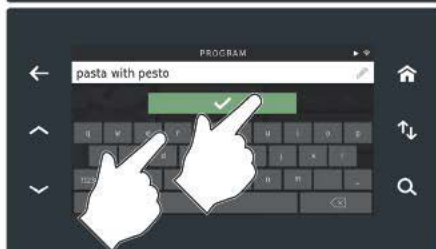

Manual modification of parameters of new program (name, photo, timer, humidity and temperature)

Touch the corresponding field, set the value and confirm with "✓" or cancel by going back with <-.



setting the holding temperature



Setting the percentage of humidity in the cavity

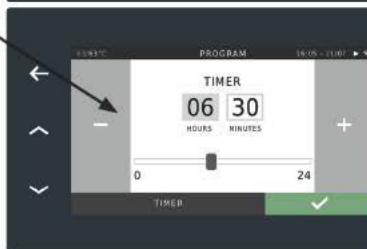

setting the preserving time

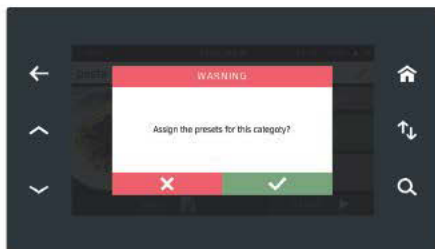

❗ If, with the parameters already set, the food category is changed, EVEREO® will ask if you want to update the program settings with the parameters of the new category or if you wish to keep the values which have already been entered.

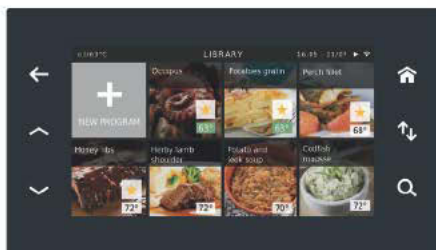

Using a “SUPERHOLDING MODE - preservation” program that’s already present

- A** Access the “SUPERHOLDING” library



- B** Look for a program which meets your requirements using the arrows  or by clicking on the symbol : this way you can order the recipes alphabetically, by favourites or by temperature.



If you want, immediately start up the program, see page [36](#)

If programs have already been started at a different humidity level than the program you want to run, the Start button is disabled.

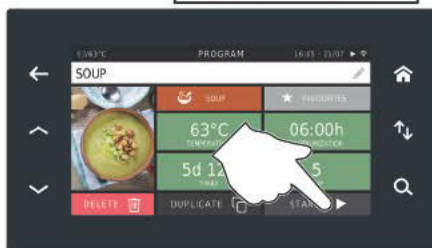

Up to 72 hours: Preservation (MEAL ME MODE) - vacuum-packed portions

Within the “Meal me” library you can find the programs of the foods you can acquire on the portal:

www.mealmefood.com.

 The parameters of these programs **cannot be changed**; it is, however, possible to mark them as **favorites** or set a **reorder point (ROP)** for the program’s portions.



The screen shown is an example; it depends on the programs set by the user.

Completing program (reorder point and/or favorite)

If you want, set a **reorder point (ROP)**: this value allows EVEREO® to advise when the portions of this food are running low (in the example EVEREO® flags up when 7 portions remain) so there is time for them to be re-stocked.

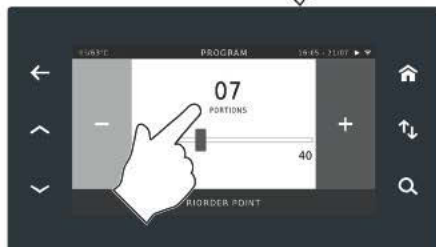

If you want, select the “★ Favorites” button to add the program to the rapid access program list.

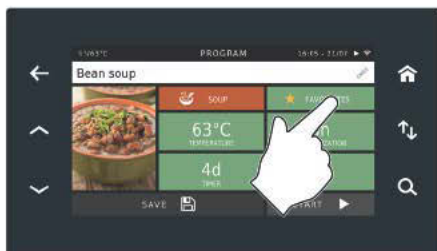

D) T.BOOST mode - preparing food for service

T.BOOST mode increases the temperature of Evereo for a set period of time, to reheat food before serving it to customers.

Interface shown in countries with the MEAL ME service



Interface shown in countries without the MEAL ME service



! The T.BOOST functions are the same for both interfaces.

- ① To reheat food stored in Evereo, select T.BOOST mode to start heating to 80°C.



- ② T.BOOST mode can automatically change the times to suit the new conditions in the cavity. The parameter can be activated from the settings menu (page 61).

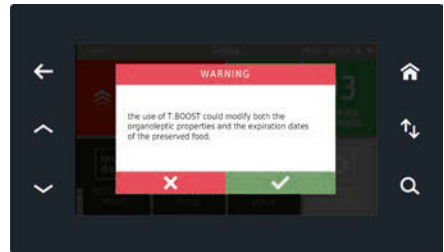

- ③ The Evereo temperature is raised to 80°C and maintained for a set period of time (default 2 hours). The time and temperature parameters can be customised from the settings menu (page 61).



- ④ You can deactivate T.BOOST mode by selecting the icon on the HOME screen.

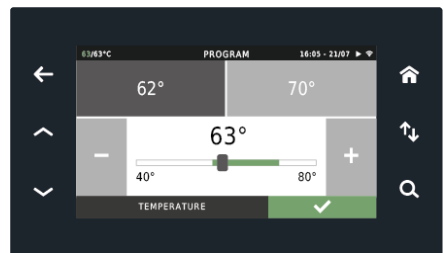

E) Starting up the program selected

If the parameters of the program selected have been changed (e.g. the temperature has been changed), it is possible to:

- **(A) start up the program directly without saving it** in the library (the next time it is started up the program will again have the default parameters). In this event, just start the program selected by pressing "START".

- **(B1) save the changes made** (the values of the fields concerned will be replaced) and then **(B2) start the program**.

- **(C)** In this event, if necessary, the recipe can be deleted **(C)** or copied **(D)**.

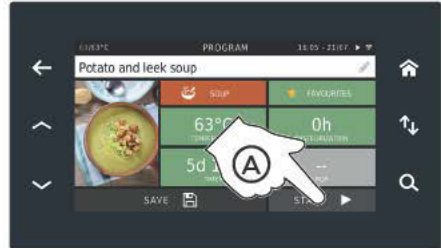

Starting the program (without reorder point) in TRAY mode

Start the program by pressing "START". If the set point temperature of EVEREO® is different from that of the program which has been started, the latter cannot be started. I can, however, decide to start it by deleting the set point temperature and the programmes that are active in EVEREO®.



Enter the portions in EVEREO® and set the **tray number** (e.g. 03) where the portions have been placed (the number is laser stamped on each tray).

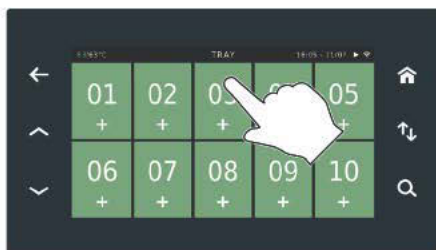

A If the parameter "always require portions numbers" (see page 14) was previously set at **OFF** the program starts immediately.

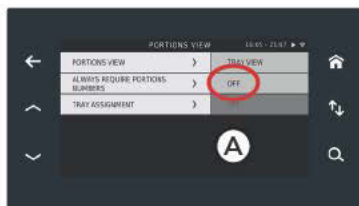

B If the parameter "always require portions numbers" (see page 14) was previously set at **ON** the program asks for the portions number to be entered. Use the "+" key to get to the desired number (e.g. 12) and confirm with "✓".

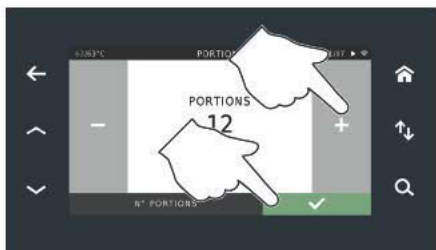
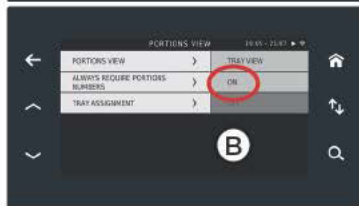

The program has now started: the screen which appears shows all the data for the process in progress:

A TRAY: indicates the number of the tray (e. g. 03)

B INFO: this button displays all the information for the individual timer.

C TIMER LIST: for each Timer a new item is created in the list (up to a maximum of 5 timers). This way EVEREO® can make a distinction between the portions which have been put in at different times.

D PORTIONS: since no reorder point (ROP) has been set, only a dash is shown.

E EXPIRE AT / EXPIRE IN: Shows that:

Case A: The program is in the pasteurization phase: it is a timer that specifies how much time will be required by EVEREO® to pasteurize the food. It is not possible to serve the product before the timer runs down

Case B: The program is in the pre-serving phase: Timer that shows the time available to keep the food in EVEREO®, beyond which the portion is considered expired



Expire data

TIMER	PORTIONS	EXPIRE DATA	
PASTEURIZATION			Case A
01	12	5d 12h ✖	Case B

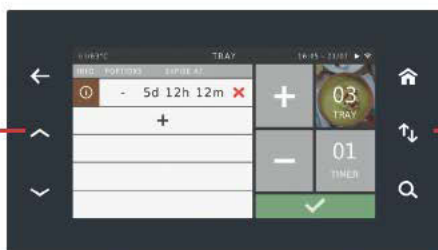

Starting the program (with reorder point) in TRAY mode

Start the program by pressing "START". If the set point temperature of EVEREO® is different from that of the program which has been started, the latter cannot be started. I can, however, decide to start it by deleting the set point temperature and the programmes that are active in EVEREO®.



Enter the portions in EVEREO® and set the **tray number** (e.g. 03) where the portions have been placed (the number is laser stamped on each tray).

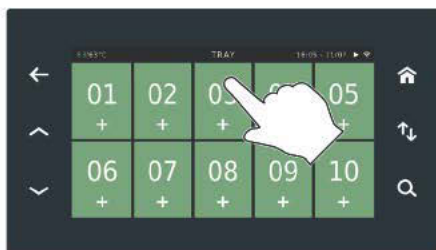

Set the number of portions entered by using the “+” key to get to the desired number (e.g. 12) and confirm with “√”.



The program has now started: the screen which appears shows all the data for the process in progress:

(A) TRAY: indicates the number of the tray (e.g. 03)

(B) ROP: indicates the reorder point, namely the number of portions below which you will receive a notification (e.g. 05)

(C) INFO: this button displays all the information for the individual timer.

(D) PORTIONS: only if a reorder point (ROP) has been set. Indicates the number of portions present in EVEREO®.

(E) EXPIRE AT / EXPIRE IN:
Shows that:

Case A: The program is in the pasteurization phase: it is a timer that specifies how much time will be required by EVEREO® to pasteurize the food. It is not possible to serve the product before the timer runs down

Case B: The program is in the preserving phase: Timer that shows the time available to keep the food in EVEREO®, beyond which the portion is considered expired

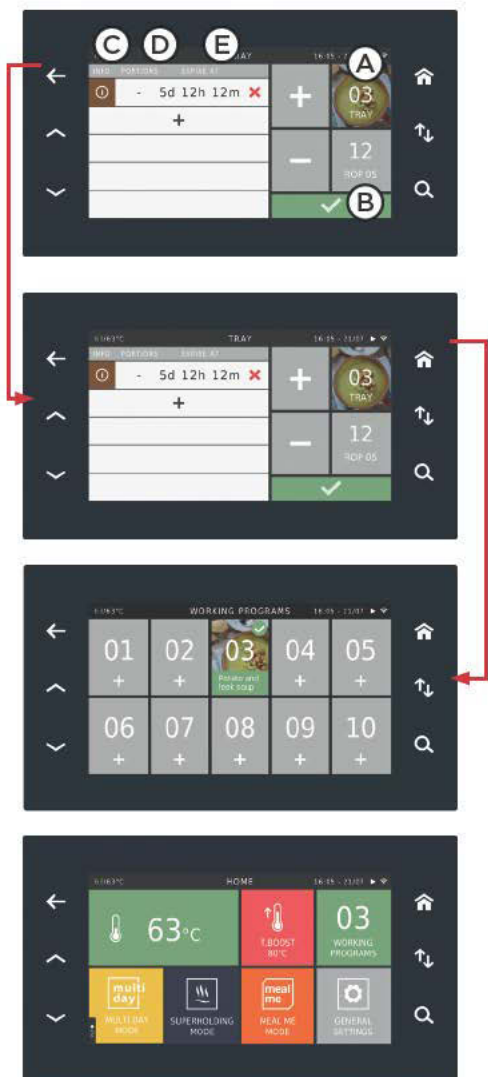

How portions are managed in tray mode

The screen to the side appears each time the door is opened.

From here you can:

- **remove** or **add** portions from/to a tray (e.g. I have taken some from tray 03) ► go to point **(A)** on page 41

- **load a program** on a new tray put in ► go to point **(B)** on page 43

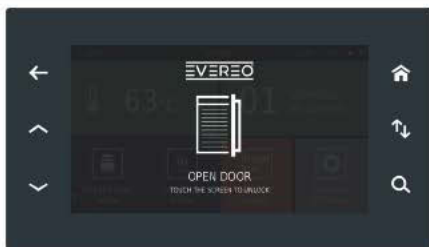

(A) If the door has been opened because portions have been **removed**, touch the relevant tray (e.g. 03), and set the number of portions removed using the "-" button (in the example, 2 portions have been removed therefore I go from 12 to 10). Confirm with "✓".

(!) If I make a mistake and remove extra portions, I can use the "+" button but only up to the number of portions I started with (e.g. 12). No corrections can be made after confirmation using "✓".

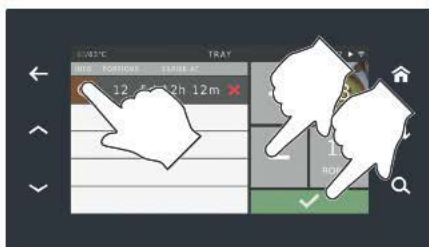





If the door has been opened because portions have been **added**, touch the relevant tray (e.g. 03), click on the add portion button "+", set the number of portions and confirm with "✓".

The last screen shows that tray 03 has:

- a timer with 10 portions with a preserving time of between 3 days and 8 hours
- a timer with 7 portions giving a total of 17 portions



 The colours next to the timer indicate the day on which the package was put in (Monday=brown, Tuesday=yellow, etc.)

	01	10	3d 8h	
	02	07	5d 12h	

They refer to the coloured labels on the packaging of the portions themselves.



The colours can be deactivated or changed by accessing the Settings menu.

See colour setting on page [61](#)

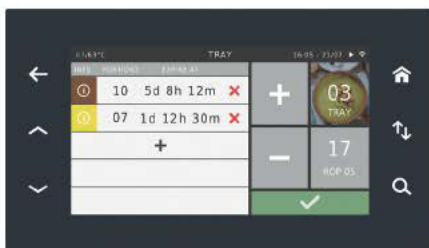
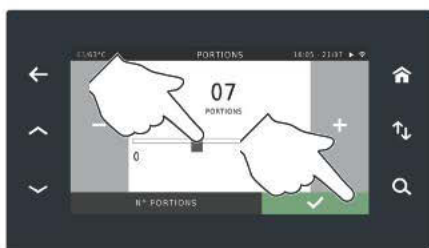
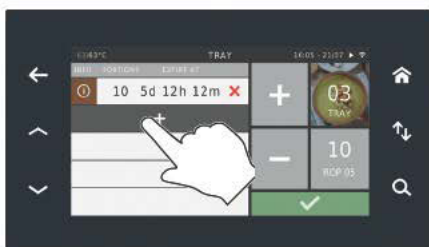
To cancel a whole block of portions, simply touch the "X" symbol. Confirm with "✓" or cancel with "X".



B To load a new program on a tray:

- go into WORKING PROGRAMS,
- enter the portions in EVEREO® and set the **tray number** (e.g. 09) where they have been placed (the number is laser stamped on each tray),
- select the mode (e.g. MULTI DAY MODE),
- use the arrows  to select the required program,
- if necessary, modify the parameters  see page 24 and 30) or start the program directly by pressing the "START" button,



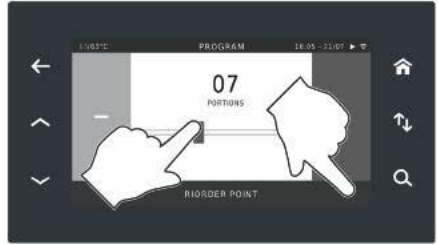

- set the **number of portions put in** (e.g. 7) using the “-” and “+” buttons or by dragging the cursor. Confirm with “✓” or cancel with “X”.

The program has now started.

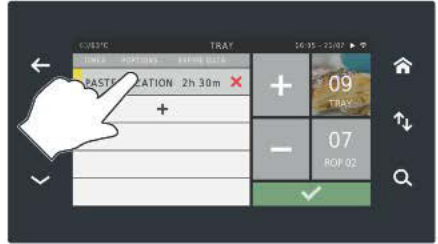

Warnings in tray view:



product expiring One or more portions of tray 3 have expired or are about to expire
portion numbers low

The portions in tray 3 are lower in number than those specified in the reorder point



portions regenerating

The portions in tray 3 cannot be served yet as they are being pasteurized



optimum conservation

There are no problems with the portions in tray 3

Starting the program in LIST mode

If the set point temperature of EV-EREO® is different from that of the program which has been started, a pop-up will ask you what you want to do:

- ✓: you want to continue: the set point temperature is cancelled and the program starts; any active programs will be cancelled.
- ✗: the program is not started



A If the parameter “tray assignment” (see page 14) was previously set at **ON** the program asks for the required tray to be selected (e.g. 5).

B If the parameter “tray assignment” (see page 14) was previously set at **OFF** the tray assignment screen does not appear.

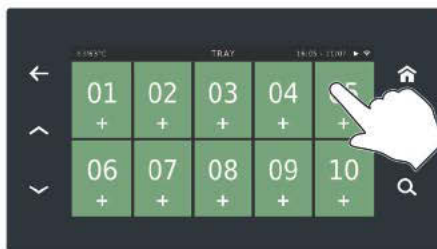
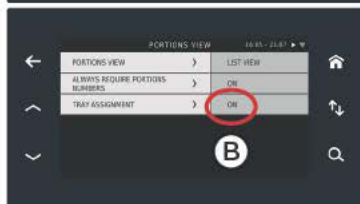
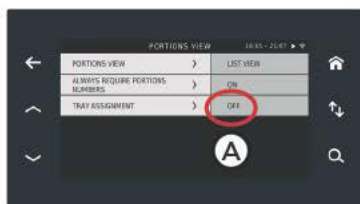

EN

Ⓐ If the parameter “always require portions numbers” (see page 14) was previously set at **OFF** the program starts immediately.

Ⓑ If the parameter “always require portions numbers” (see page 14) was previously set at **ON** the program asks for the portions number to be entered. Use the “+” key to get to the desired number (e.g. 12) and confirm with “√”.

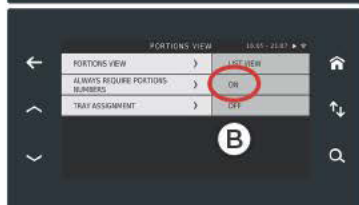
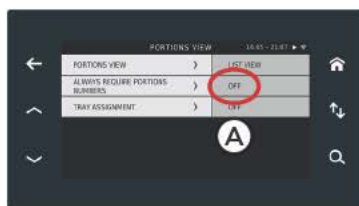

If the program has an **ROP (reorder point) number**, when it starts it will ask for the portions that will be put in (even if the parameter “always require portions numbers” is disabled).



Set the **number of portions put in** (e.g. 12) using the “-” and “+” buttons or by dragging the cursor. Confirm with “✓” or cancel with “x”.

This parameter must be entered in order to ensure correct management of the reorder point.



The program **TIMER** has now started: the screen which appears is in the list view.

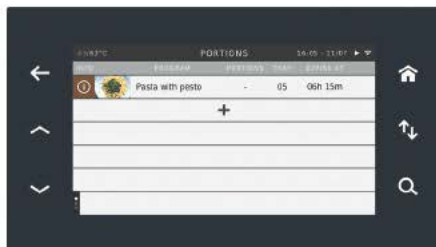

The screen to the side appears each time the door is opened to remove a portion



From here you can:

- **remove** portions by selecting the relevant row ► go to point **(A)** on page 41

- **add** portions by creating a new program ► go to point **(B)** on page 41



A If the door has been opened because portions have been removed, touch the relevant tray (e.g. 03) and set the number of portions removed using the “-” button (in the example, 4 portions have been removed therefore I go from 10 to 6).
Confirm with “✓”.

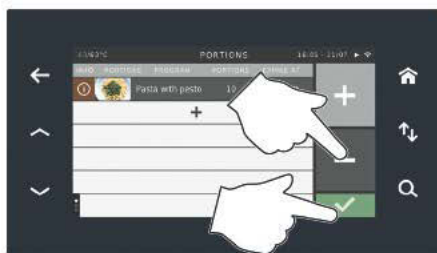

! If I make a mistake and remove extra portions, I can use the “+” button but only up to the number of portions I started with (e.g. 10). No corrections can be made after confirmation using “✓”.



B To **add** new portions, create a new program for each addition:

- introduce the portions into EV-EREO®
- touch the empty row with the +
- select the mode (e.g. MULTI DAY MODE),
- use the arrows  to select the required program.



The program settings are displayed. These can be modified (▶ see page 24 and page 30) or start the program directly by pressing the “START” button.

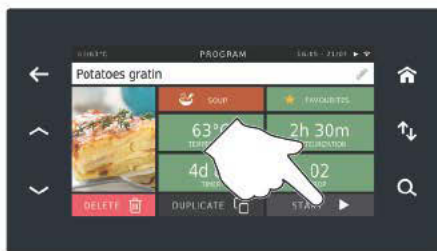

If the parameter “always require portions numbers” (see page 14) was previously set at **ON**, it is necessary to set the **number of portions put in** (e.g. 12) using the “-” and “+” keys or by dragging the cursor. Confirm with “✓” or cancel with “✗”.

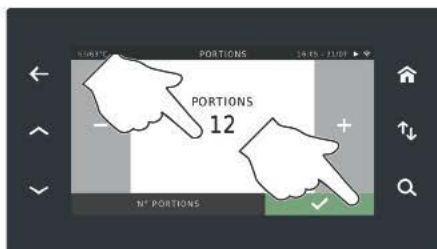

 The colours next to the timer indicate the day on which the package was put in (Monday=brown, Tuesday=yellow, etc.)



They refer to the coloured labels on the packaging of the portions themselves. The colours can be deactivated or changed by accessing the Settings menu. See colour setting on page 61



Possible problems: portions about to expire

TIMERS ready to expire flash red (e.g. Timer 01)



Managing programs with reorder point

PROGRAM WITH ROP

If an ROP (reorder point) has been entered in the program, when I start it in List mode, the value “Portions” lets me see how many portions I have put in and how much the program’s ROP is (in time intervals)

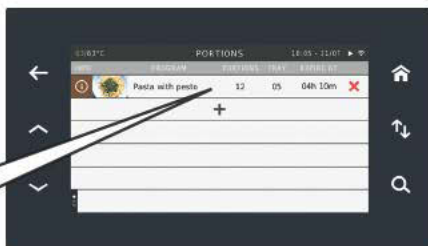
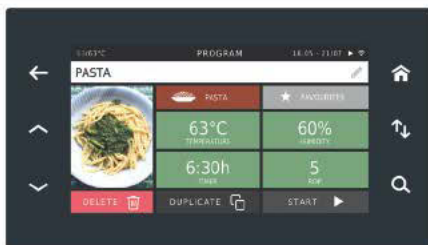

	Pasta with pesto	ROP 06	05	04h 10m	
+					

Insert new portion

If I start the program again to put in new portions, the list will show the two “Pasta with pesto” timers and the “portions” field will show how many portions there are in the individual timer and how many there are in Evereo.



	Pasta with pesto	12/18	05	04h 10m	
	Pasta with pesto	06/18	05	06h 29m	

18 total portions
1st timer: 12 portions
2nd timer: 6 portions

If there are fewer portions than the ROP

If there are fewer portions than the ROP set, the Portions section goes red.



	Pasta with pesto	ROP 06	05	04h 10m	
	Pasta with pesto	ROP 06	05	06h 29m	



F) Switching off the appliance

EVEREO® can be switched off in one of two ways:

- **without active programs** ► go to point **(A)**
- **with active programs** ► go to point **(B)**

The screen at the top appears when EVEREO® does not have any active programs (00 WORKING PROGRAMS).

- (A)** In this case, touch the "temperature" symbol and the word "OFF".

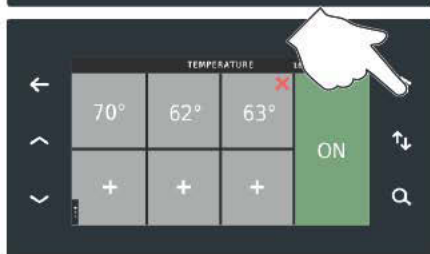

The screen at the top appears when EVEREO® has active programs (in the example, 03 WORKING PROGRAMS).

In this case, touch the "temperature" symbol and the word "OFF".

Ⓑ

A pop-up appears which asks for confirmation: confirm with "✓" or cancel with "✗".

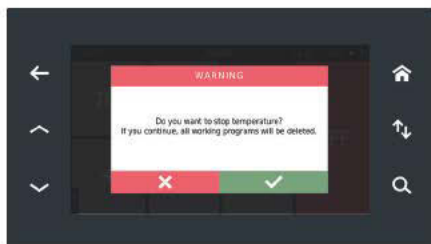
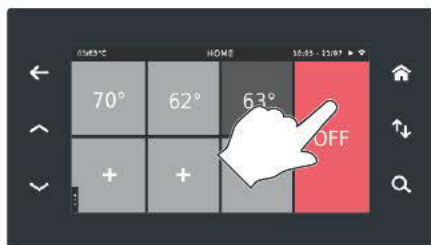

AN EXTRA FUNCTION: TIMER

- ① This function lets you set a simple timer where no other parameter is set.



- ② Select an empty tray (e.g. 09).



- ③ Select the "TIMER" function.



- ④ Set the required time and confirm with "✓".

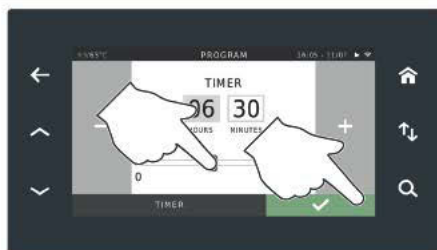

- If the parameter "ALWAYS REQUIRE PORTIONS NUMBERS" is active in settings

- ⑥ Indicate the number of portions (e.g. 07) and confirm with "✓".

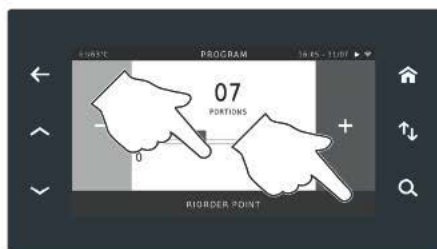

7

The screen to the side shows a timer that has been started and the tray screen.



G) SETTINGS

To access the EVEREO® settings, it is recommended that the temperature be switched off and all active programs cancelled.

From the HOME screen, select "GENERAL SETTINGS".

Enter the User password: **4456**

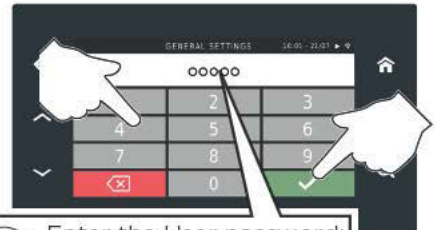
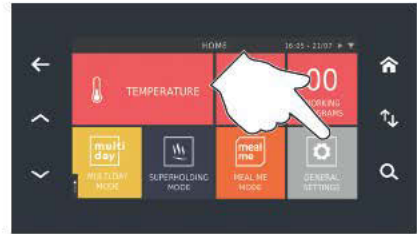

Enter the User password: **4456**

LANGUAGE: Change system language

DATE AND TIME: Clock settings

PREFERENCES: Preferences menu for Evereo (display mode, unit of measure, etc.)

MEALME PREFERENCES Preferences menu for EVEREO® (display mode, unit of measure, etc.)

USB: Set/export programs, images and HACCP data

NETWORK: Settings for the internet connection



LANGUAGE



To change the system language, access the LANGUAGE menu and select the relevant language. Use the arrows to scroll through the screens.



DATE AND TIME



Access the DATE AND TIME menu to set the date and time.

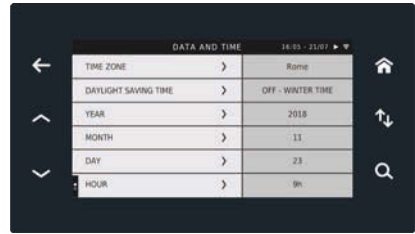

MEALME PREFERENCES



To manage the programs and images of the Meal Me Mode library programs. If a lot of programs have expired (no longer sold on the Meal Me portal), you can delete them from this menu.

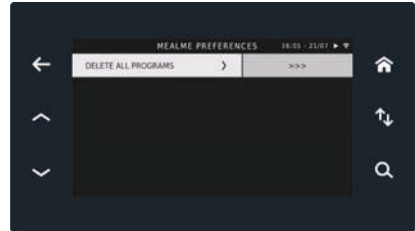

USB



The USB interface can be used to import/export Programs, photos and HACCP data from EVEREO®. Connect the flash drive to the USB port in the control panel and enter the USB menu. Select the required option.



USB PORT ON FRONT PANEL.
Lift the silicon tab and insert the USB flash drive

NETWORK



By accessing the NETWORK menu, I can enter the internet connection settings so that I can access MealMe and receive software updates.

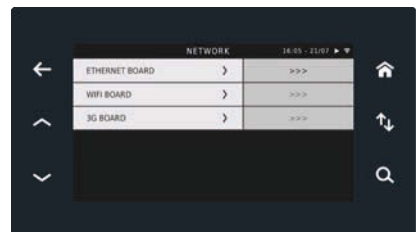

PREFERENCES



UNIT OF MEASURE:
Temperature in °C or °F

PORTIONS VIEW:
Portions display mode (TRAY or LIST).
It is not possible to change the display if EVEREO® is in operation.

LOCKING: Enables or disables the EVEREO® functions so as to limit operator actions.

ON locking enabled
OFF locking disabled

LIST ORDER: Setting program display order within the “MULTI DAY MODE”, “SUPERHOLDING MODE” and “MealMe mode” libraries.

T.BOOST: this sets the time and temperature for T.BOOST mode.

STANDBY: Switch off times of SCREEN and LED.

MY PHOTOS: Display/delete photos imported from the flash drive.

BUZZER: Sets the acoustic signals for EVEREO® (end of maintaining a program, touch feedback, alarms)

DAY DOTS: Sets the colours for the daily portions (labels).

RESET: To delete programs, temperatures, reset system

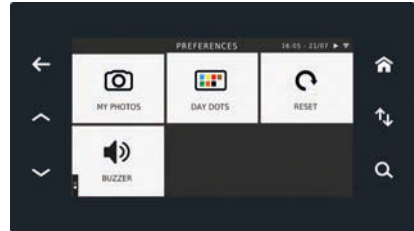
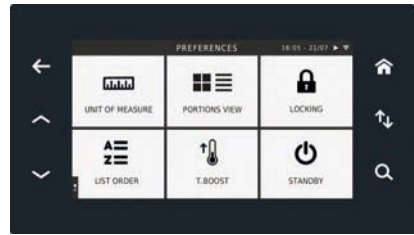

UNIT OF MEASURE



From the UNIT OF MEASURE menu I can select °C or °F



PORTION VIEW



I can select the portion management mode by selecting TRAY VIEW or LIST VIEW. Switch off the temperature and delete the programs in progress to access this menu.

Also from this menu I can activate or deactivate the request to insert the portions number (at program start-up) or the request to insert the tray number (only if list display is selected)

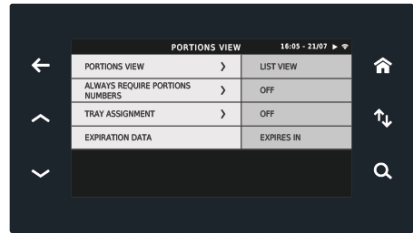

LOCKING



From the LOCKING menu I can enable and disable the EVEREO® functions so as to limit operator actions.

ON locking enabled

OFF locking disabled

Functions that can be deactivated:

LOCK START TIMER:
Deactivates quick TIMERS.

LOCK SUPERHOLDING MODE:
Locks access to the SUPERHOLDING MODE library, preventing the introduction of open foods.

LOCK ADD NEW PROGRAM:
Disables the first button of the libraries which allows the creation of new programs.

LOCK MODIFY PROGRAM:
Prevents the possibility of modifying a saved program.

LOCK DELETE PROGRAM:
Prevents the possibility of deleting a saved program.

LOCK DELETE PROGRAM IN REGEN:
Prevents the pasteurisation program from being deleted.



CODE:

The password you need to use to start at a temperature of below 59°C. As the default setting, the password is 12345

LIST ORDER



The settings of the LIST ORDER menu allow you to set the display order of the portions within the libraries.

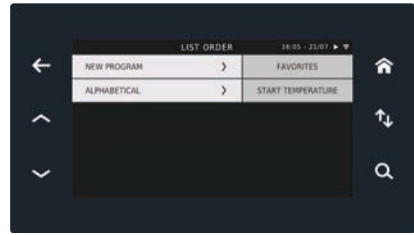

STAND-BY



PANEL: The EVEREO® panel can go into standby to save energy. From this menu, the timer can be activated as well as the time after which it will switch off after a period of inactivity.
LEDBAR: The LEDs which provide light in the cavity come on when the door is opened. These can be switched off when the door is closed or by defining a specific switch-off time.



BUZZER



The settings of the LIST ORDER menu allow you to activate the acoustic warnings that mark:- Feedback on touch on panel- Program end timer alarm- Generic alarms



MY PHOTOS



You can load (or delete) personal pictures in the MY PHOTOS menu



DAY DOTS



If using labels to identify the portions introduced into EVEREO®, I can select colours to be assigned to each day (e.g. blue label for portions introduced on Monday, yellow labels for portions introduced on Tuesday etc.).

I can deactivate this function by selecting the first box next to the days.

As soon as I access this screen, the first row is selected. Touch the symbol of the colour I want to set for Monday, the selection will be applied automatically and the second item in the list will be selected (TUESDAY).

If the colour selected has already been assigned to another day of the week, the colour will be assigned to the new day and removed from the one it belonged to before.

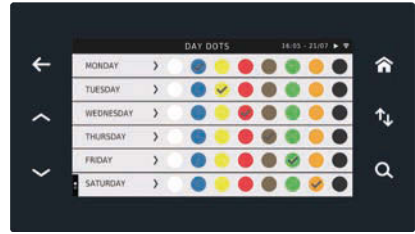

RESET



From the RESET menu I can delete all the saved programs, all the temperatures or all the data (Programs, Temperatures, Images loaded).



T.BOOST



Adjust the time, temperature and timer settings for T.BOOST mode. The optimal parameters for T.BOOST mode are 80°C for 120 minutes.

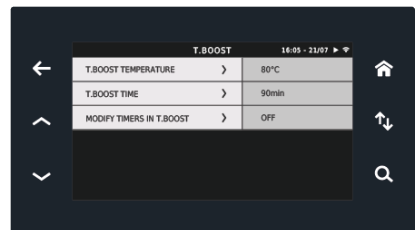

H) CONFIGURING AND USING EVEREO SAFE.LOCK

SUPER USER ACCESS PROCEDURE

In SAFE.Lock mode, the EVEREO® panel is locked.

To unlock the panel, enter the four-digit password provided in the manual attached to the appliance packaging.

After unlocking the panel, you have full access to all EVEREO® functions.

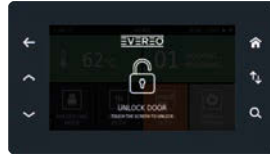

LOADING USER PASSWORDS

1) Create a .txt text file to save the user passwords.

- Passwords must contain at least five numbers (be careful with blank spaces);
- Start a new line for each password.
- After the password, you may wish to enter the name associated with the PIN, so you can monitor access by downloading the log from the USB menu.

Example:

```
*PIN_CODES - Blocco note di Windows
File Modifica Formato Visualizza ?
00000 Utente 1
1111 Utente 2
22222 Utente 3
```

2) Saving the file:

- On a USB key, create a new folder and call it "UNOXDIR";
- Create another folder in the UNOXDIR folder and call it "PINS";
- Save the text file in the "PINS" folder, giving it the name "PIN_CODES.txt".

Example:

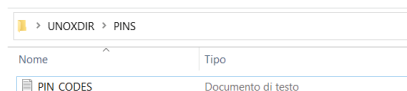

Log in as a SUPER USER and access the **“GENERAL SETTINGS”** menu using the password **4456**.



Insert the USB key in the relevant port next to the panel and access the USB menu.

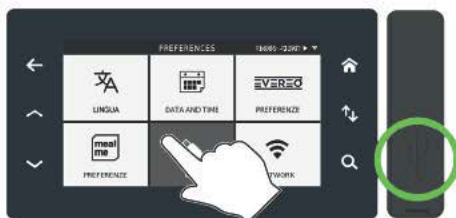

Select **“IMPORT AND ENABLE PIN CODES”** and wait for the passwords to load.



EN

USER USAGE PROCEDURE

In SAFE.Lock mode, the Evereo® panel is locked.

Tap the screen to enter the PIN.

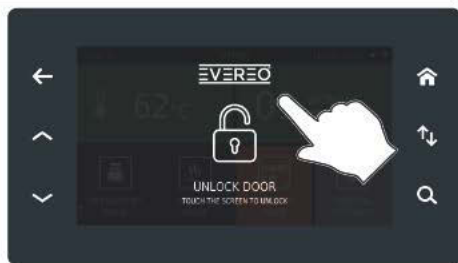

Log in using your five-digit password.

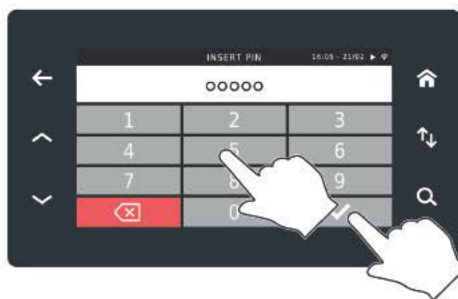

Once access has been granted, Evereo® unlocks the door, allowing you to remove the food.



Once you have removed the food, shut the door again.

⚠ For security reasons, if the door is not opened within five seconds, Evereo® locks the system again.

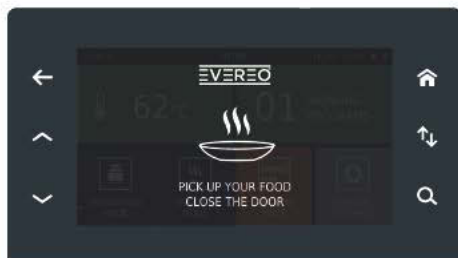

DOWNLOADING THE ACCESS LOG

Log in as a SUPER USER and access the **“GENERAL SETTINGS”** menu using the password **4456**.



Insert the USB key in the relevant port next to the panel and access the USB menu.

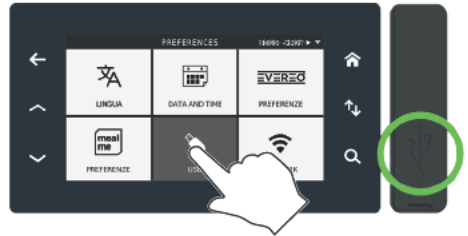

Select **“EXPORT HACCP TO USB”** and wait for the file to download.

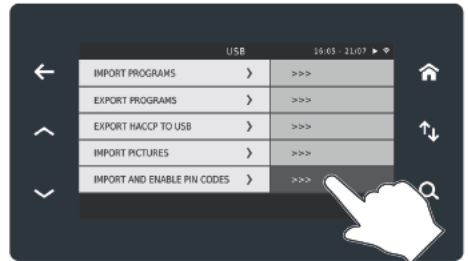

1) How to read the HACCP file.

Every time you enter a PIN to unlock the appliance, this is automatically recorded in the .CSV file containing HACCP data.

The following information is saved:

- date
- time
- PIN.

HACCP DATA
USER ACCESS

SUPER USER ACCESS

22/12/2020	12:52:42	1	645 709 677 81 C
27/01/2021	11:01:18	1	SUPERUSER PIN
28/01/2021	12:01:07	1	12345 :PIN

ALARMS

Symbol	Description
T_{setpoint}	Setpoint temperature
T_{S1}	Temperature measured by probe S1
T_{S2}	Temperature measured by probe S2
T_{average}	Average of S1 and S2 temperatures
D_T	Difference in temperature between S1 and S2
timeout	Detection time (generic)
t_{black}	Blackout duration
t_{door}	Door opening duration
t_{repast}	Repasteurization duration

The holding cabinet detects and flags up the following hardware malfunctions:

Code	Description	Conditions	String displayed (ENGLISH)
WP01	Setpoint temperature not reached, within 30 minutes of start-up of machine.	<ol style="list-style-type: none"> 1) Evereo ON 2) At least ONE probe operating 3) The door is closed 4) $T_{\text{average}} < T_{\text{setpoint}}$ 5) timeout > 30 min. 	WARNING WP01 LOW TEMPERATURE (HEATING ELEMENT ERROR)
WP02	Temperature lower than set point, during operation of the machine.	<ol style="list-style-type: none"> 1) Evereo ON 2) At least ONE probe operating 3) The door is closed 4) $T_{\text{average}} < T_{\text{setpoint}} - 0.5^{\circ}\text{C}$ 5) timeout > 30 min. 	WARNING WP02 LOW TEMPERATURE (PRESERVE FOOD IN ANOTHER WAY)
WP03	Temperature exceeds maximum value	<ol style="list-style-type: none"> 1) Evereo ON 2) At least ONE probe operating 3) T_{S1} or T_{S2} or $T_{\text{average}} > 100^{\circ}\text{C}$ 	WARNING WP03 HIGH TEMPERATURE (HEATING ELEMENT ERROR)
WP04	S1 probe broken or malfunctioning	<ol style="list-style-type: none"> 1) S1 does not measure/fail state 2) S2 working correctly 	WARNING WP04 PROBE ERROR (PROBE 1)

Code	Description	Conditions	String displayed (ENGLISH)
WP05	S2 probe broken or malfunctioning	1) S2 does not measure/fail state 2) S1 working correctly	WARNING WP05 PROBE ERROR (PROBE 2)
WP06	Probes broken or malfunctioning	1) S1 does not measure/fail state 2) S2 does not measure/fail state	WARNING WP06 PROBES ERROR (PRESERVE FOOD IN ANOTHER WAY)
WP07	Fan not working	1) Evereo ON 2) S1 working correctly 3) S2 working correctly 4) $D_T > 10^\circ\text{C}$ 5) timeout > 30 min.	WARNING WP07 FAN ERROR (PRE- SERVE FOOD IN ANOTHER WAY)
WP08	--	--	--
WP09	Humidity probe broken or malfunctioning.	1) Evereo ON 2) Humidity probe does not measure/fail state	WARNING WP09 PROBE ER- ROR (HUMIDITY PROBE)
WP10	Max. temperature allowed by the safety thermostat reached	1) Safety thermostat digital alarm input ON	WARNING WP10 TEMPERATURE THERMOSTAT
WP11	Max. permitted motor temperature reached	1) Motor thermal alarm digital input ON	WARNING WP11 FAN THERMO- STAT

NOTIFICATIONS

Symbol	Description
T_{setpoint}	Setpoint temperature
T_{S1}	Temperature measured by probe S1
T_{S2}	Temperature measured by probe S2
T_{average}	Average of S1 and S2 temperatures
D_T	Difference in temperature between S1 and S2
H_{setpoint}	Humidity setpoint
timeout	Detection time (generic)
t_{black}	Blackout duration
t_{door}	Door opening duration
t_{repast}	Repasteurization duration

The holding cabinet raises the following notifications regarding the goodness of the product being kept:

Code	Dependent upon	Description	Conditions	Consequences	String displayed (ENGLISH)
HAZ01	BLACKOUT	Following a blackout, the food being preserved might have to undergo a repasteurization phase.	See table of repasteurization times	* For blackouts lasting less than 120 min, any programs loaded will be updated, subtracting the time from the timer; * For blackouts lasting more than 120 min, the user can choose to DELETE ALL the active programs, or to REPASTEURIZE	BLACKOUT HAZ01- THE FOOD'S ORGANOLEPTIC PROPERTIES COULD BE COMPROMISED. CHECK THE FOOD'S STATUS BEFORE PROCEEDING WITH REPASTEURIZATION
HAZ02	OPENING DOOR	Following prolonged opening of a door, the food being preserved might have to undergo a repasteurization phase.	See table of repasteurization times	* For doors being open for less than 120 min, any programs loaded will be updated, subtracting the time from the timer; * For doors being open for more than 120 min, the user can choose to DELETE ALL the active programs, or to REPASTEURIZE	OPEN DOOR HAZ02 - THE FOOD'S ORGANOLEPTIC PROPERTIES COULD BE COMPROMISED. CHECK THE FOOD'S STATUS BEFORE PROCEEDING WITH REPASTEURIZATION.

Code	Dependent upon	Description	Conditions	Consequences	String displayed (ENGLISH)
HAZ03	WPO2 / SET TEMPERATURE LOWER THAN 59°C	<p>A distinction must be made between three cases: 1) The holding cabinet does not maintain the temperature. It is recommended that the food preserved be removed (WPO2 has arisen);</p> <p>2) The holding cabinet does not maintain the temperature and goes below 59°C (WPO2 has arisen); 3) the holding cabinet has been started with a temperature below 59°C (WPO2 has not arisen).</p>	<p>timeout > 120 minutes</p>	<p>A distinction must be made between three cases:</p> <p>1) As it is ABOVE the safety temperature, ALL the programs can be REPASTEURIZED or DELETED;</p> <p>2) As it is BELOW the safety temperature, ALL the programs must be DELETED;</p> <p>3) As the temperature has been set MANUALLY and KNOWINGLY, it is just a notification, no action is necessary.</p>	<p>LOW TEMPERATURE HAZ03 - THE FOOD'S ORGANOLEPTIC PROPERTIES COULD BE COMPROMISED.</p>
HAZ04	WPO6	<p>The holding cabinet cannot maintain the temperature because of breakage of BOTH probes. It is advisable for the preserved food to be removed.</p>		<p>It is not possible to repasteurize it, only to DELETE the active programs.</p>	<p>PROBES ERROR HAZ04 - THE FOOD'S ORGANOLEPTIC PROPERTIES COULD BE COMPROMISED. PRESERVE FOOD IN ANOTHER WAY.</p>

Code	Dependent upon	Description	Conditions	Consequences	String displayed (ENGLISH)
HAZ05	WPO7	The temperature inside the holding cabinet is stratified. It is advisable for the pre-served food to be removed.	timeout > 120 minutes	It is not possible to repasteurize it, only to DELETE the active programs.	FAN ERROR HAZ05 - THE FOOD'S ORGANOLEPTIC PROPERTIES COULD BE COMPROMISED. PRESERVE FOOD IN ANOTHER WAY.
HAZ06	only MULTI DAY MODE type programmes are active	The humidity measured is higher than the threshold set to mark the breakage/opening of a container.	H > LHCF (see Parameters 2.0) timeout > LHTF (see Parameters 2.0)	This is just a notification, no action is necessary.	HUMIDITY HAZ06 - POSSIBLE FOOD SEAL BROKEN. CHECK THE FOOD'S STATUS BEFORE PROCEEDING WITH REPASTEURIZATION.

Code	Dependent upon	Description	Conditions	Consequences	String displayed (ENGLISH)
HAZ03	WPO2 / SET TEMPERATURE LOWER THAN 59°C	<p>A distinction must be made between three cases: 1) The holding cabinet does not maintain the temperature. It is recommended that the food preserved be removed (WPO2 has arisen);</p> <p>2) The holding cabinet does not maintain the temperature and goes below 59°C (WPO2 has arisen); 3) the holding cabinet has been started with a temperature below 59°C (WPO2 has not arisen).</p>	<p>timeout > 120 minutes</p>	<p>A distinction must be made between three cases:</p> <p>1) As it is ABOVE the safety temperature, ALL the programs can be REPASTEURIZED or DELETED;</p> <p>2) As it is BELOW the safety temperature, ALL the programs must be DELETED;</p> <p>3) As the temperature has been set MANUALLY and KNOWINGLY, it is just a notification, no action is necessary.</p>	<p>LOW TEMPERATURE HAZ03 - THE FOOD'S ORGANOLEPTIC PROPERTIES COULD BE COMPROMISED.</p>
HAZ04	WPO6	<p>The holding cabinet cannot maintain the temperature, because of the breakage of BOTH probes. It is advisable for the preserved food to be removed.</p>		<p>It is not possible to repasteurize it, only to DELETE the active programs.</p>	<p>PROBES ERROR HAZ04 - THE FOOD'S ORGANOLEPTIC PROPERTIES COULD BE COMPROMISED. PRESERVE FOOD IN ANOTHER WAY.</p>

PASTEURIZATION TIMES TABLE

Condition	Dependent upon	Pasteurization duration
$120 \text{ min} < t_{\text{black}} < 180 \text{ min}$	HAZO1	4 hours*
$180 \text{ min} < t_{\text{black}} < 240 \text{ min}$		6 hours*
$t_{\text{black}} > 240 \text{ min}$		8 hours*
$120 \text{ min} < t_{\text{door}} < 180 \text{ min}$	HAZO2	4 hours*
$180 \text{ min} < t_{\text{door}} < 240 \text{ min}$		6 hours*
$t_{\text{black}} > 240 \text{ min}$		8 hours*

* always check the state of the food before starting a repasteurization phase.

Notes:

- If the residual timer is less than the repasteurization time required to guarantee the goodness of the food, this is marked as EXPIRED a priori.
- If a program is already in a repasteurization phase and an event occurs which requires a new repasteurization phase, this will be marked as EXPIRED a priori.
- Starting up a repasteurization or deletion process are actions that are NON-REVERSIBLE.

TABLE OF OPTIMUM SETTINGS FOR PRESERVATION

Category	Temp.	Regeneration and pasteurisation time			Optimal preserving time**
		Chilled temp. (0-4°C)	Ambient temp. (20-57°C)	Hot food* (more than 58°C)	
red meat	62°C	3h35m + 2h25m	2h30m + 2h25m	0m	3 days
white meat	62°C	3h35m + 2h25m	2h30m + 2h25m	0m	3 days
chicken	62°C	3h35m + 2h25m	2h30m + 2h25m	0m	3 days
fish	62°C	3h35m + 2h25m	2h30m + 2h25m	0m	3 days
legumes	70°C	3h35m + 2h25m	2h30m + 2h25m	0m	3 days
vegetables	62°C	3h35m + 2h25m	2h30m + 2h25m	0m	3 days
soups	70°C	3h35m + 2h25m	2h30m + 2h25m	0m	3 days
pasta	62°C	3h35m + 2h25m	2h30m + 2h25m	0m	3 days
rice	62°C	3h35m + 2h25m	2h30m + 2h25m	0m	3 days
sauces	62°C	3h35m + 2h25m	2h30m + 2h25m	0m	3 days

* at least 2 hours of pasteurization are recommended, even when food is put in hot (with a temperature above 58°C).

** Pasteurization time calculation is based on average considerations. If food below 60°C is placed in EVEREO to cook/regenerate, the temperature of the food must be monitored to verify that the time/temperature profile is food safe and specifically to ensure that meets required standards to disable target microorganism.



SERVING TEMPERATURE HOLDING CABINET

Maintenance

ROUTINE MAINTENANCE

! Any routine maintenance procedure must be performed:

- after having disconnected the appliance from the power and water supplies
- after having put on the proper personal protective equipment (gloves, etc.).

Clean the appliance on a daily basis in order to maintain a good level of hygiene and to avoid corrosion or deterioration of the stainless steel. When cleaning any component or accessory NEVER use:

- abrasive or powder detergents;
- aggressive or corrosive detergents (e.g. hydrochloric/muriatic or sulphuric acid). Warning! Do not use these substances to clean the table under the appliance either;
- abrasive or sharp tools (abrasive sponges, scrapers, steel-bristled brushes, etc.);
- water jets.

EXTERNAL STEEL STRUCTURES, CAVITY SEAL

! Wait for the surfaces to cool off.

Use only a soft cleaning cloth dampened with a little soap and water. Rinse and dry completely. As an alternative, only use detergents recommended by the appliance manufacturer; other products may cause

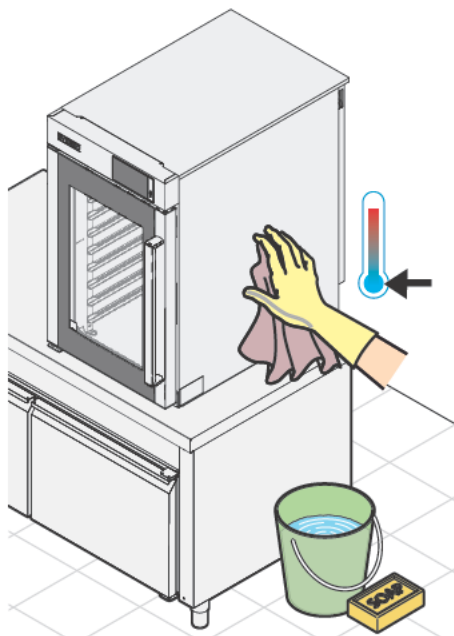

damage, thereby invalidating the warranty and any other contractual relationship with the manufacturer and its subsidiaries/associates. Read the usage instructions provided by the detergent manufacturer.

INSIDE AND OUTSIDE DOOR GLASS PANEL

! Wait for the glass to cool off.

Use only a soft cleaning cloth dampened with a little soapy water or detergent specifically designed for glass. Rinse and dry completely.

INTERNAL CAVITY



If food residue accumulates in the cavity, clean it immediately to avoid the risk of fire.

Clean the cavity by hand using a soft cloth dampened with a non-corrosive, non-abrasive and non-aggressive cleaner for stainless steel surfaces.

Remove the side grills to make cleaning easier.

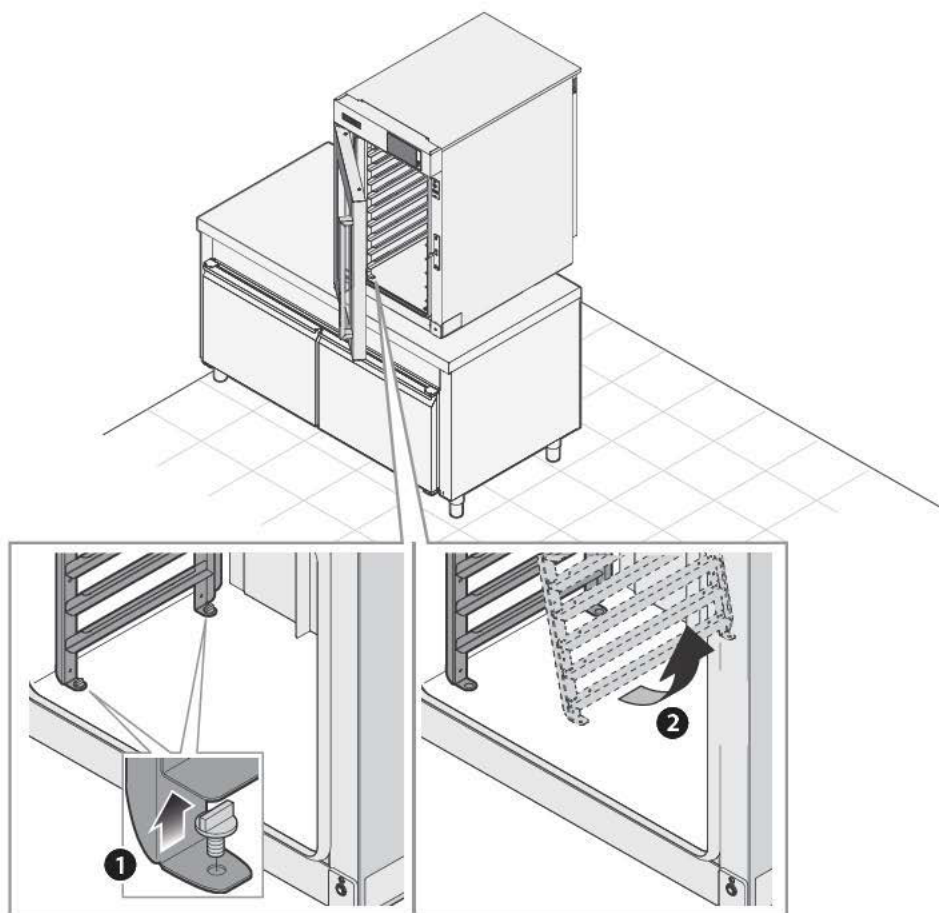

INACTIVITY

During periods of inactivity, take the following precautions:

- disconnect the appliance from the power supply;
- preferably rub a soft cloth lightly dampened with mineral oil on all stainless steel surfaces;

Before reusing the appliance:

- clean the appliance and its accessories thoroughly (see section “[Maintenance](#)” on page 74);
- reconnect the appliance to the power supply;
- inspect the appliance.

AFTER-SALES ASSISTANCE

In the event of a fault, disconnect the appliance from the power supply and contact the manufacturer.

CERTIFICATION

EU declaration of conformity for electrical appliances

Manufacturer: UNOX S.p.A.

Address: Via Majorana, 22 - 35010 Cadoneghe, Padua, Italy
declares, under its own responsibility, that the product

EVEREO™

complies with the Machinery Directive 2006/42/EC through the following standards:

EN 60335-1: 2014 + A1:2014

EN 60335-2-42: 2003 + A1: 2008 + A1:2012

EN62233: 2008

EN 60335-2-102:2006 + A1:2010

complies with the Electromagnetic Compatibility Directive 2014/30/EC through the following standards:

EN 55014-1: 2006 + A1: 2009 + A2: 2011

EN 55014-2: 1997 + A1: 2001 + A2: 2008

EN 61000-3-2: 2006 + A1: 2009 + A2: 2009

EN 61000-3-3: 2008

EN 61000-3-11: 2000

EN 61000-3-12: 2011

EN 61000-6-2: 2005

EN 61000-6-3: 2007

WARRANTY

This product must only be installed by a support service authorised by the manufacturer. The installation date and appliance model must be documented by the end purchaser, by means of written confirmation or an installation invoice issued by the dealer or a support service authorised by the manufacturer.

The manufacturer's warranty covers all malfunctions objectively linked to production defects. The warranty excludes damage due to transport, poor product storage or holding, and incorrect product use. Also excluded is damage

due to installation which does not comply with the technical specifications provided by the manufacturer and linked to the usage environment, such as unclean and aggressive water, or an unsuitable electrical supply voltage or current.

The warranty also excludes any damage due to power surges or tampering by unauthorised or incompetent persons. The warranty is also invalidated in the event of damage to the appliance or malfunctioning caused by limescale deposits. In addition, the warranty does not cover consumable parts such as seals, light bulbs, glass panels, decorative parts and parts consumed during use.

The warranty is also invalidated in the event of damage caused by incorrect installation, or installation not carried out by an authorised support service.

DISPOSAL

Pursuant to article 13 of Legislative Decree 49 of 2014 "Implementation of the WEEE Directive 2012/19/EU on electrical and electronic equipment waste"



The crossed-out wheellie bin symbol specifies that the product was placed on the market after 13 August 2005 and that at the end of its useful life it should be collected separately and not disposed of with other waste.

All appliances are made with recyclable metal materials (stainless steel, iron, aluminium, galvanized steel, copper, etc.) in percentages above 90% by weight. Before disposal, make the appliance unusable by removing the power cable and all compartment or cavity closure devices (where present). At the end of its useful life, the product must be disposed of in such a way as to reduce any negative impact on the environment and make efficient use of available resources. Prefer prevention, preparation for reuse, recycling and reclamation, and remember "the polluter pays". Please remember that illegal or incorrect disposal of the product incurs penalties, as provided for by current legislation.

Information on disposal in Italy

In Italy, WEEE appliances must be delivered to:

- recycling centres (also known as waste disposal sites/facilities)
- the dealer from whom the new appliance is purchased, who is required to collect them free of charge ("one-for-one" collection).

Information on disposal in European Union countries

The EU Directive on WEEE appliances has been implemented differently by each country. Therefore, if you want to dispose of this appliance, we recommend you contact your local authorities or dealer for information on the correct disposal method.



INVENTIVE SIMPLIFICATION

EUROPE

IT - ITALIA
UNOX S.p.a

E-mail: info@unox.it
Tel: +39 049 8657511

GB - UNITED KINGDOM
UNOX UK Ltd.

E-mail: info@unoxuk.com
Tel: +44 1252 851 522

CZ - ČESKÁ REPUBLIKA
UNOX DISTRIBUTION s.r.o.

E-mail: info.cz@unox.com
Tel: +420 241 940 000

BG - БЪЛГАРИЯ
UNOX BULGARIA

E-mail: info.bg@unox.com
Tel: +359 2 419 05 00

NL - NETHERLANDS
UNOX NETHERLANDS B.V.

E-mail: info.nl@unox.com
Tel: +31 6 27 21 14 10

DE - DEUTSCHLAND
UNOX DEUTSCHLAND GMBH

E-mail: info.de@unox.com
Tel: +49 2951 98760

IE - IRELAND
UNOX IRELAND

E-mail: info.ie@unox.com
Tel: +353 (0) 87 52 23 218

HR - HRVATSKA
UNOX CROATIA

E-mail: narudzbe@unox.com
Tel: +39 049 86 57 538

AT - ÖSTERREICH
UNOX ÖSTERREICH GMBH

E-mail: info.de@unox.com
Tel: +43 800 880 963

PL - POLSKA
Unox Polska Sp.zo.o.

E-mail: info.pl@unox.com
Tel: +48 665 232 000

FR - FRANCE, BELGIUM
& LUXEMBOURG
UNOX FRANCE s.a.s.

E-mail: info.fr@unox.com
Tel: +33 4 78 17 35 39

ES - ESPAÑA
UNOX PROFESIONAL
ESPAÑA S.L.

E-mail: info.es@unox.com
Tel: +34 900 82 89 43

TR - TÜRKİYE - UNOX TURKEY
Profesyonel mutfak ekipmanları
endüstri ve ticaret limited şirketi

E-mail: info.tr@unox.com
Tel: +90 530 176 62 03

RU - РОССИЯ, ПРИБАЛТИКА
И СТРАНЫ СНГ
UNOX РОССИЯ

E-mail: info.ru@unox.com
Tel: +7 (499) 702 - 00 - 14

SC - SCANDINAVIAN
COUNTRIES
UNOX SCANDINAVIA AB

E-mail: info.se@unox.com
Tel: +46(0)790 75 63 64

PT - PORTUGAL
UNOX PORTUGAL

E-mail: info.pt@unox.com
Tel: +351 918 228 787

AMERICA

US - U.S.A. & CANADA
UNOX Inc.

E-mail: info.usa@unox.com
Tel: +1 800 489 8669

AR - ARGENTINA
UNOX ARGENTINA

E-mail: info.ar@unox.com
Tel: +54 911 37 58 43 46

CO - COLOMBIA
UNOX COLOMBIA

E-mail: info.co@unox.com
Tel: +57 350 65 88 204

BR - UNOX BRASIL
SERVICOS LTDA.

E-mail: info.br@unox.com
Tel: +55 11 98717-8201

MX - MEXICO
UNOX MEXICO,
S. DE R.L. DE C.V.

E-mail: info.mx@unox.com
Tel: +52 55 8116-7720

ASIA, OCEANIA & AFRICA

ZA - SOUTH AFRICA
UNOX SOUTH AFRICA

E-mail: info.sa@unox.com
Tel: +27 845 05 52 35

PH - PHILIPPINES
UNOX PHILIPPINES

E-mail: info.asia@unox.com
Tel: +63 9175108084

AU - AUSTRALIA
UNOX AUSTRALIA PTY Ltd.

E-mail: info@unoxaustralia.com.au
Tel: +61 3 9876 0803

UZ - UZBEKISTAN
UNOX PRO LLC

E-mail: info.uz@unox.com
Tel: +998 90 370 90 10

KR - 대한민국
UNOX KOREA CO. Ltd.

이메일: info.asia@unox.com
전화: +82 2 69410351

AC - OTHER
ASIAN COUNTRIES
UNOX (ASIA) SDN. BHD

E-mail: info.asia@unox.com
Tel: +603-58797700

TW - TAIWAN,
HONG KONG & MACAU
UNOX TAIWAN

E-mail: info.tw@unox.com
Tel: +886 928 250 536

MY - MALAYSIA
& SINGAPORE
UNOX (ASIA) SDN. BHD

E-mail: info.asia@unox.com
Tel: +603-58797700

CN - 中华人民共和国
UNOX TRADING (SHANGAI)
Ltd. CO.

电子邮件: info.asia@unox.com
电话: +603-58797700

NZ - NEW ZEALAND
UNOX NEW ZEALAND Ltd.

E-mail: info@unox.co.nz
Tel: +64 (0) 800 76 0803

AE - U.A.E.
UNOX MIDDLE EAST DMCC

E-mail: info.uae@unox.com
Tel: +971 4 554 2146

ID - INDONESIA
UNOX INDONESIA

E-mail: info.asia@unox.com
Tel: +62 81908852999

unox.com



L11522A4

All images used are for illustrative purposes only.
All features indicated in this catalogue may be subject to change and could be updated without notice.