

1.9L Thermal Carafe (1pk)

Height: 7.3" Width: 6.6" Depth: 9.2"
(18.5cm) (16.8cm) (23.4cm)

- Holds 64oz (1.9L) of coffee or other hot beverages
- Unbreakable stainless steel interior and exterior
- Vacuum insulation keeps beverages hot for hours
- Brew through lid allows for direct brewing
- Fits on BUNN Thermal Carafe and Twin Thermal Carafe brewers



Agency:

Specifications

Product #: 51746.0001

Finish: Stainless/Black

Handle: Black

Liner: Stainless Steel

Additional Features

Brew-Through Lid

Seamless Design

Holding Capacity

English	Metric
64 oz.	1.9 L

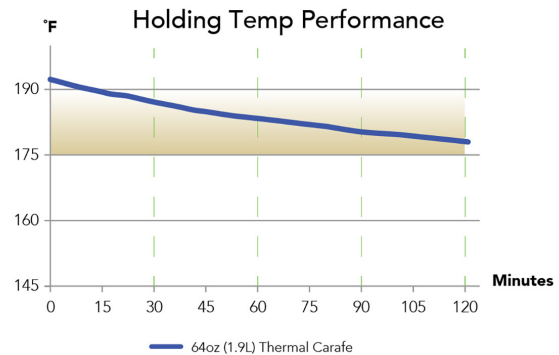

Footnote: - Brewer tank temperature set at 205° F
- Servers not preheated (preheating may increase temperature up to 5° F)
- 64oz (1.9L) of coffee brewed
- Temperature recorded in server

WARNING:



BUNN® reserves the right to change specifications and product design without notice. Such revisions do not entitle the buyer to corresponding changes, improvements, additions or replacements for previously purchased equipment. For most current specifications and other info visit bunn.com.

Last Updated:
04/26/2024

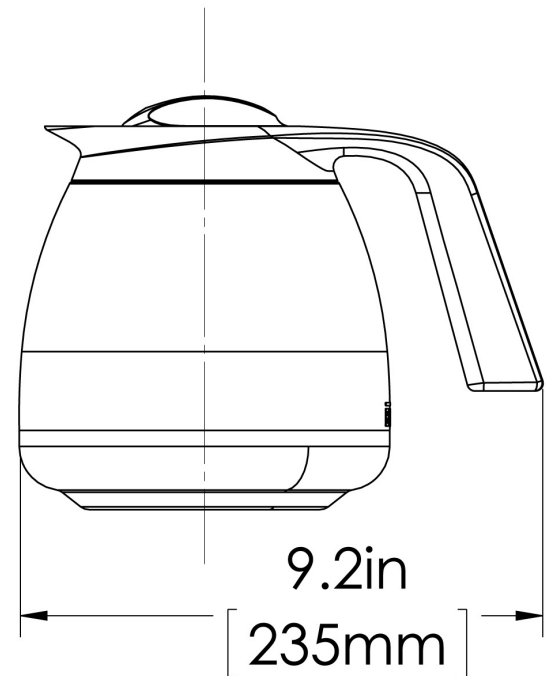
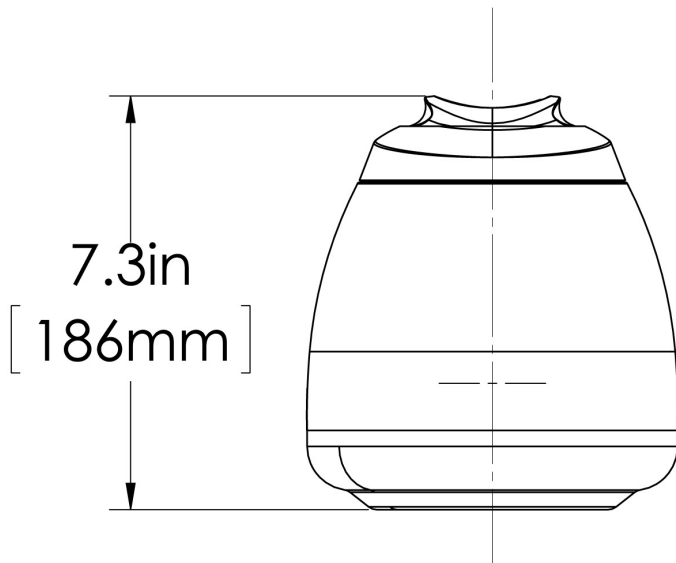
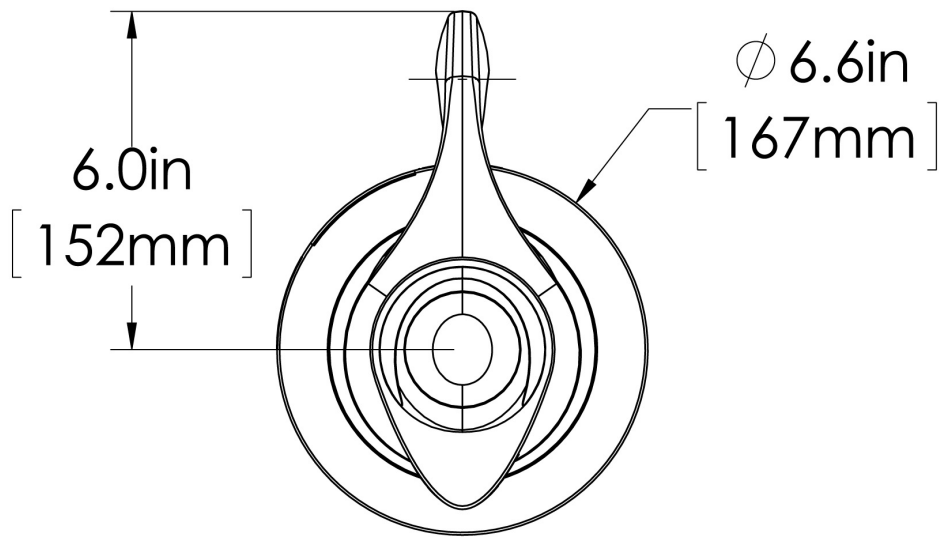

	Unit			Shipping				
	Height	Width	Depth	Height	Width	Depth	Weight	Volume
English	7.3 in.	6.6 in.	9.2 in.	7.6 in.	6.8 in.	8.0 in.	2.240 lbs	0.236 ft ³
Metric	18.5 cm	16.8 cm	23.4 cm	19.2 cm	17.1 cm	20.3 cm	1.016 kgs	0.007 m ³



BUNN® reserves the right to change specifications and product design without notice. Such revisions do not entitle the buyer to corresponding changes, improvements, additions or replacements for previously purchased equipment. For most current specifications and other info visit bunn.com.

Last Updated:
04/26/2024

Related Products & Accessories: 1.9L Thermal Carafe (1pk)(51746.0001)

LID, SEAMLESS
THERMAL CARAFE BLK

Product #: 52547.0000

LID, SEAMLESS
THERMAL CARAFE ORN

Product #: 52547.0001



BUNN® reserves the right to change specifications and product design without notice. Such revisions do not entitle the buyer to corresponding changes, improvements, additions or replacements for previously purchased equipment. For most current specifications and other info visit bunn.com.

Last Updated:
04/26/2024

Model Compatibility: 1.9L Thermal Carafe (1pk)(51746.0001)



CWTF15-TC, PF

Product #:12950.0360



CWTF TWIN-TC, 120/240V
SF

Product #:23400.0047



AXIOM-DV-TC, PF SST
HOUSING

Product #:38700.0011

WAVE15-APS, LP PF

Product #:39900.0000



BUNN® reserves the right to change specifications and product design without notice. Such revisions do not entitle the buyer to corresponding changes, improvements, additions or replacements for previously purchased equipment. For most current specifications and other info visit bunn.com.

Last Updated:
04/26/2024